

Inspiring Motion

Since 1988

Gold Eagle HV

Gold Eagle HV Cable Kit (EtherCAT and CAN)

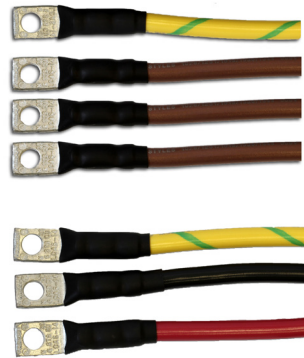
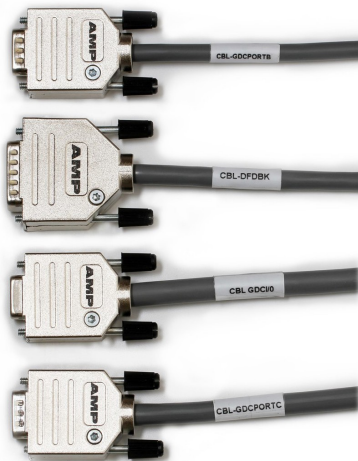

July 2020 (Ver. 2.200)

www.elmomc.com

Elmo
Motion Control

Notice

This guide is delivered subject to the following conditions and restrictions:

- This guide contains proprietary information belonging to Elmo Motion Control Ltd. Such information is supplied solely for the purpose of assisting users of the Gold Eagle HV servo drive in its installation.
- The text and graphics included in this manual are for the purpose of illustration and reference only. The specifications on which they are based are subject to change without notice.
- Information in this document is subject to change without notice.

Document no. MAN-G-EAGHV-CBLKIT (Ver. 2.200)

Copyright © 2020

Elmo Motion Control Ltd.

All rights reserved.

Catalog Number

CBL-GEAGHVKIT

Revision History

Version	Date	Details
Ver. 1.000	January 2014	Initial release
Ver. 2.000	April 2016	Updated drawings
Ver. 2.100	December 2019	Correction to section 3.1 Port A Cable
Ver. 2.200	July 2020	Updated catalog numbers



Chapter 1: Introduction4

1.1. Cable Kit (CBL-GEAGHVKIT)4

Chapter 2: Gold Eagle HV Power Cable Kit.....5

Chapter 3: Gold Eagle HV Communication Control Kit7

3.1. Port A Cable8

3.2. Port B Cable10

3.3. Port C Cable12

3.4. I/O Cable15

3.5. EtherCAT or CAN Communication Cable18

3.6. VL/Communication Cable21



Chapter: 1 Introduction

This document provides the wiring details for the cables used to connect Elmo's Gold Eagle HV servo drive with the end-user application. The servo drive-**side** pinouts are provided in the *Gold Eagle HV Installation Guide*.

The cables come in one length: 2 meters (6 ½ feet)

1.1. Cable Kit (CBL-GEAGHVKIT)

NOTE:

It should be noted that this kit does not include a Mini-USB communication cable. Please purchase this cable separately. This item is a standard cable that can be purchased locally.

Elmo's Gold Eagle HV Cable Kit consists of **two** cable kit sets:

ELMO Part Number	Function
CBL-DRU/EAGPOWKIT	Power cable kit for the Gold Eagle HV See section 2 Gold Eagle HV Power Cable Kit for more details
CBL-GEAGHVCKKIT	Communication Control cable kit See section 3 Gold Eagle HV Communication Control Kit for more details



Chapter: 2 Gold Eagle HV Power Cable Kit

The CBL-DRU/EAGPOWKIT power cable kit includes the following:

Pin	Function	Cables	
		Brushless Motor	Brushed DC Motor
M3	Motor phase 3	MOTOR PHASE, brown , 8 AWG	MOTOR PHASE, brown , 8 AWG
M2	Motor phase 2	MOTOR PHASE, brown , 8 AWG	MOTOR PHASE, brown , 8 AWG
M1	Motor phase 1	MOTOR PHASE, brown , 8 AWG	-
PE	Protective Earth	MOTOR PE, yellow and green , 8 AWG	MOTOR PE, yellow and green , 8 AWG
VP+	DC Positive Power input	Power In, red , 8 AWG	Power In, red , 8 AWG
VN-	DC Negative Power input	Power In, black , 8 AWG	Power In, black , 8 AWG
PE	Protective Earth	Ground, yellow and green , 8 AWG	Ground, yellow and green , 8 AWG
N	Not in use	Not in use	Not in use

Pin Positions

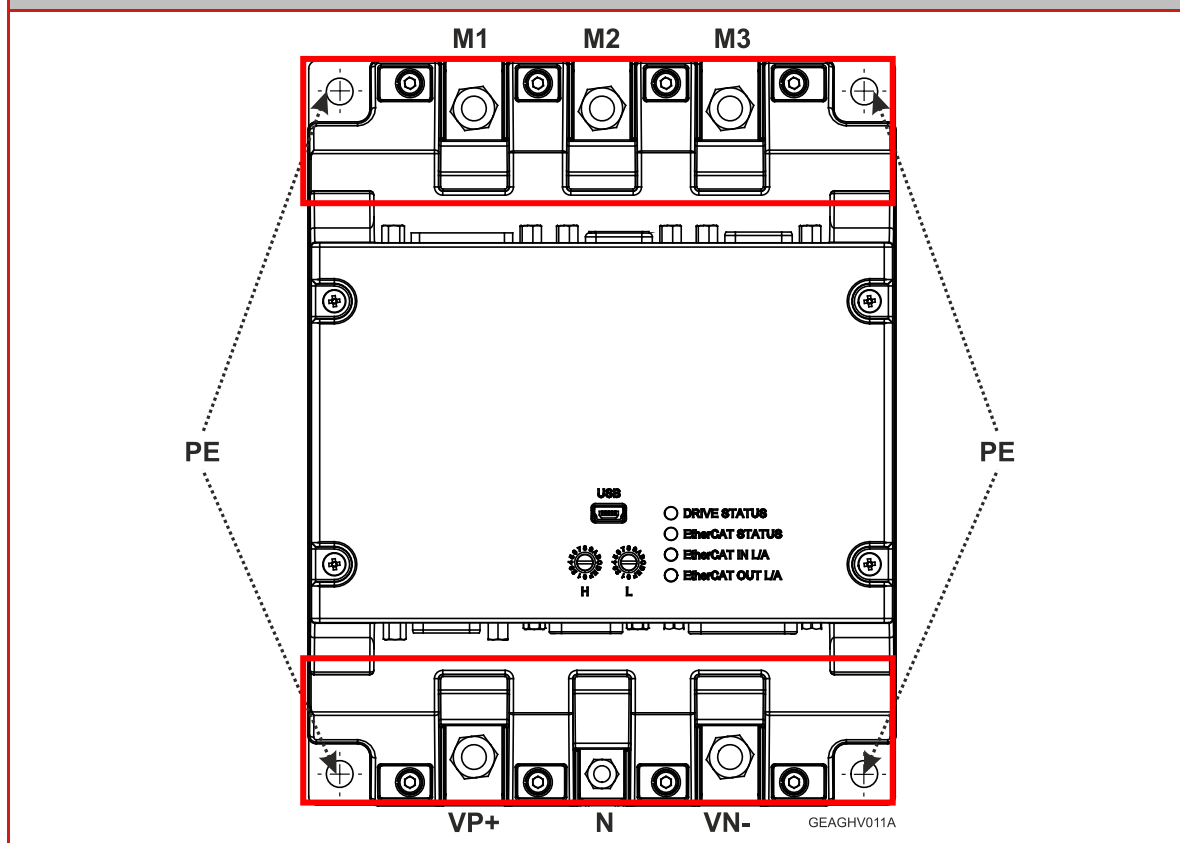



The cables are connected as follows:



Figure 1: Motor Power Cable Ends

The cables are connected as follows:



Figure 2: Main Power Cable Ends



Chapter: 3 Gold Eagle HV Communication Control Kit

The CBL-GEAGHVCKIT Communication and Control cable kit includes the following cables:

Cable No.	Function	Connector Description
CBL-DFDBK	Port A cable	15-Pin D Type Male Connector
CBL-GDCPORTB	Port B cable	9-Pin D Type Male Connector
CBL-GDCPORTC	Port C cable	15-Pin High Density D Type Male Connector
CBL-GDCI/O	I/O cable	15-Pin High Density D-Type Female Connector
CBL-GEAGHVCOM01	EtherCAT/CAN Communication cable	9-Pin D Type Female Connector
CBL-GEAGHVCOM02	VL/Communication cable	15-pin D-Type Female Connector



3.1 Port A Cable

The Port A cable is a 6-pair 24-AWG shielded twisted-pair, double shielded cable. It is connected using a D-type 15-pin male connector to the Gold Eagle HV Port A D-sub connector.

The cable is open on the feedback side so that it can be connected to the motor-feedback connector. The length of the three main cables, combining into the Port A Cable are as follows:

P/N	Length
CBL-DFDBK	2000 +/- 100mm
CBL-DFDBK-1	1000 +/- 50mm
CBL-DFDBK-5	5000 +/- 250mm

The general pinouts of the Port A cable are as follows:

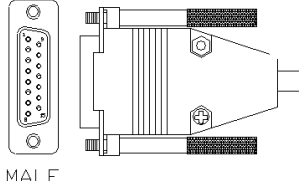
Pin No.	Signal	Color	Twisted & Shielded Wire	Plug
1	HC	Green	Twisted Pair 1	 <p>MALE</p> <p>15-Pin D Type Male Connector</p>
10	HB	Yellow		
3	COMRET	White	Twisted Pair 2	
4	+5V	Brown		
5	PortA_ENC_A-	Orange	Twisted Pair 3	
6	PortA_ENC_A+	Cyan		
7	PortA_ENC_INDEX-	Blue	Twisted Pair 4	
8	PortA_ENC_INDEX+	Red		
2	HA	Pink	Twisted Pair 5	
9	COMRET	Gray		
14	PortA_ENC_B-	Black	Twisted Pair 6	
15	PortA_ENC_B+	Purple		
11	COMRET	-	Drain Wire	



Pin Positions

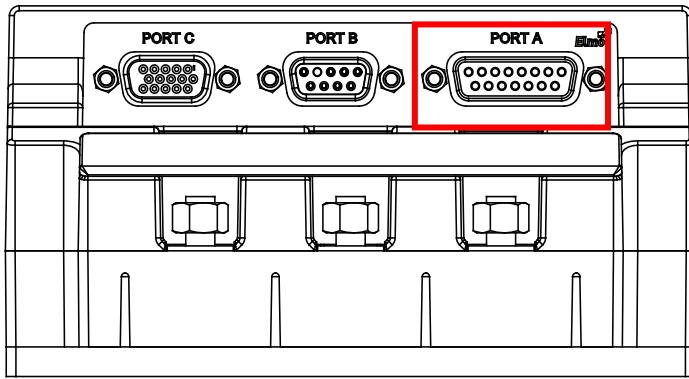

G_EAGHVCC02

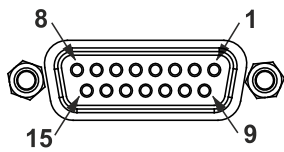

15-Pin D-Type Female Connector

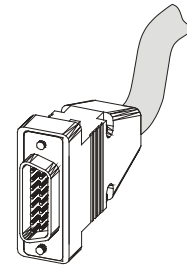

15-Pin D-Type Male Connector

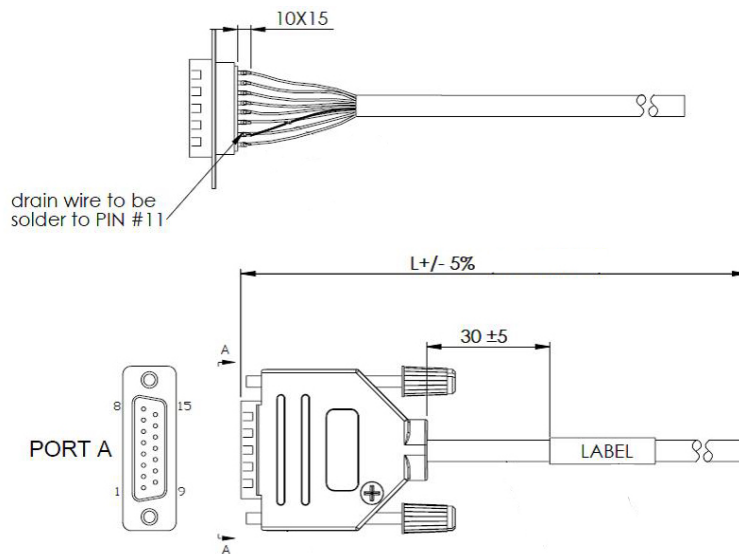

Figure 3: Feedback Port A Cable Drawing

Note: The specific functionality of each pin is described fully in the *Gold Eagle HV Installation Guide*.



Figure 4: Feedback Port A Cable – Actual



3.2 Port B Cable

The Port B cable is a 4-pair 24-AWG shielded twisted-pair, double shielded cable. It is connected using a D-type 9-pin male connector to the Gold Eagle HV Port B D-sub connector.

The cable is open on the feedback side so that it can be connected to the motor feedback connector.

The general pinouts of the Port B cable are as follows:

Pin No.	Signal	Color	Twisted & Shielded Wire	Plug
1	PortB_ENC_A+/SIN+	Brown	Twisted Pair 1	 <p>9-Pin D Type Male Connector</p>
6	PortB_ENC_A-/SIN-	White		
3	PortB_ENC_INDEX+	Red	Twisted Pair 2	
8	PortB_ENC_INDEX-	Blue		
5	COMRET	Gray	Twisted Pair 3	
4	+5V	Pink		
7	PortB_ENC_B-/COS-	Green	Twisted Pair 4	
2	PortB_ENC_B+/COS+	Yellow		
9	COMRET	-	Drain Wire	

Pin Positions

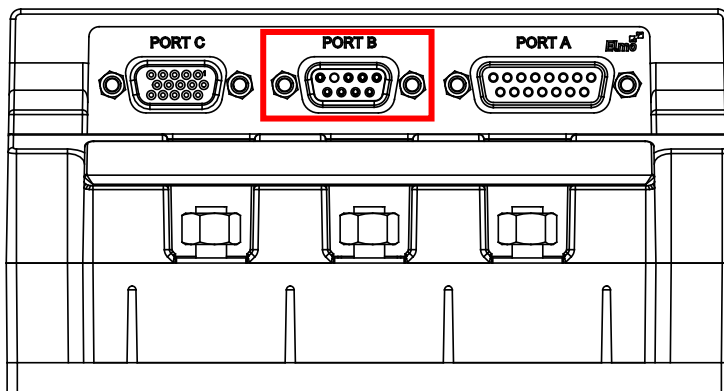

G_EAGHVCC03

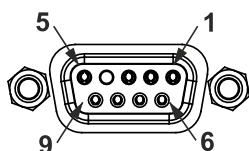

9-Pin D-Type Female Connector

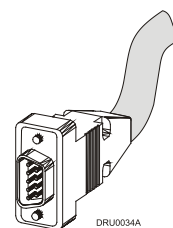

9-Pin D-Type Male Connector

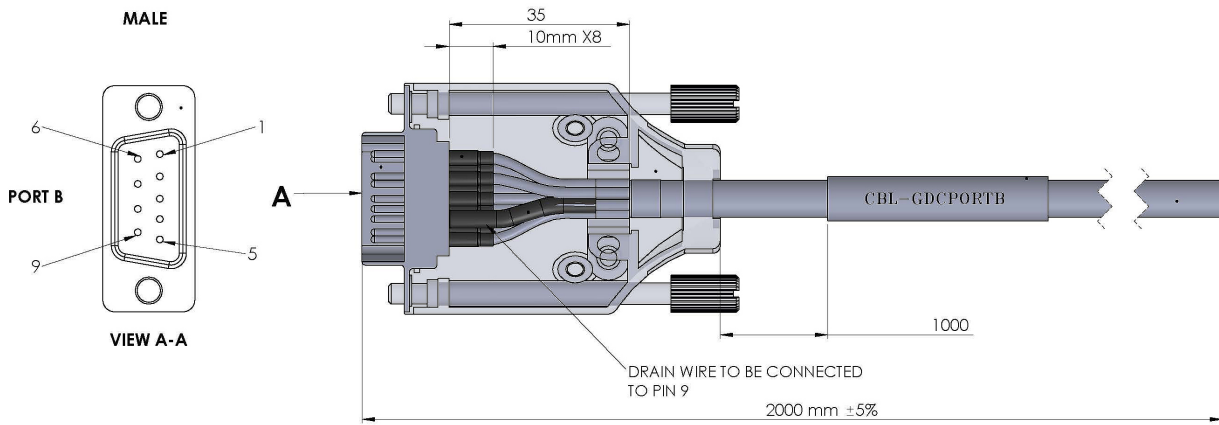

Figure 5: Feedback Port B Cable Drawing

Note: The specific functionality of each pin is described fully in the *Gold Eagle HV Installation Guide*.



Figure 6: Feedback Port B Cable Actual



3.3 Port C Cable

The Port C cable is an 8-pair 24-AWG shielded twisted-pair, double shielded cable. It is connected using a

D-type 15-pin high density male connector to the Gold Eagle HV Port C D-sub connector.

The cable is open on the user interface side so that it can be connected to the controller interface connector.

The general pinout of the Port C cable is as follows:

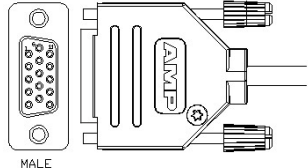
Pin No.	Signal	Color	Twisted & Shielded Wire	Plug
1	PortC_ENCO_A+	Cyan	Twisted Pair 1	 <p>15-Pin High Density D Type Male Connector</p>
2	PortC_ENCO_A-	Orange		
3	PortC_ENCO_B+	Purple	Twisted Pair 2	
4	PortC_ENCO_B-	Black		
5	PortC_ENCO_Index+	Red	Twisted Pair 3	
10	PortC_ENCO_Index-	Blue		
7	STO_RET	Gray	Twisted Pair 4	
6	STO1	Pink		
11	STO2	White/Yellow	Twisted Pair 5	
12	STO_RET	White/Green		
9	COMRET	Green	Twisted Pair 6	
13	ANARET	Yellow		
15	ANALOG+	White/Red	Twisted Pair 7	
14	ANALOG-	White/Black		
8	Reserved	Brown	Twisted Pair 8	
-	N/C	White		
*	PE	-	Drain Wire	

*** - Connector 15 Pin High Density Male Frame**



Pin Positions

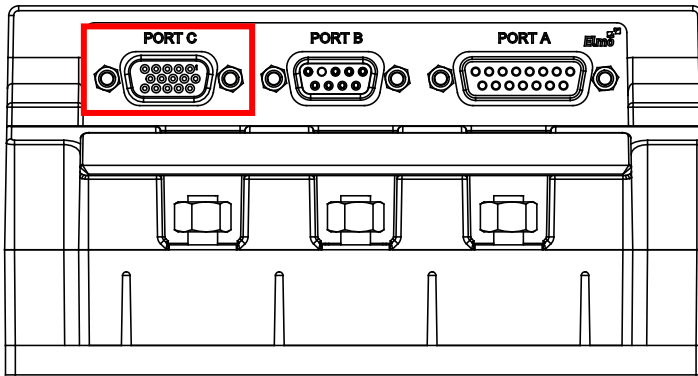

G_EAGHVCC05

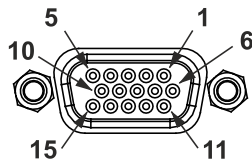

15-Pin High Density D-Type Female Connector

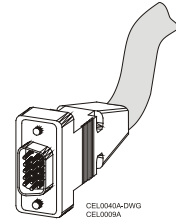

15-Pin High Density D-Type Male Connector

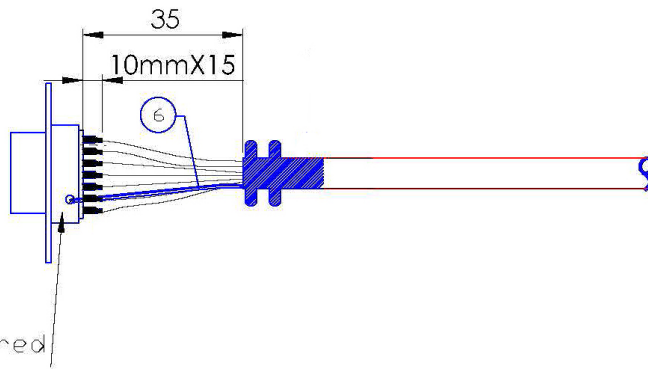

Drain Wire wire soldered to connector frame

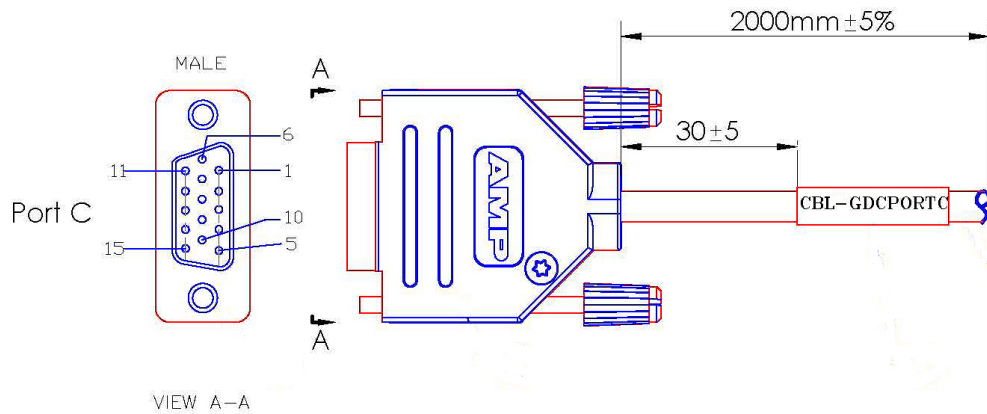

Figure 7: Port C Cable Drawing

Note: The specific functionality of each pin is described fully in the *Gold Eagle HV Installation Guide*.



Figure 8: Port C Cable Actual



3.4 I/O Cable

The I/O cable is an 8-pair 24-AWG double shielded twisted-pair cable. It is connected using a D-type 15-pin female connector to the Gold Eagle HV on the servo drive side.

The cable is open on the end side so that it can be connected to the controller interface connector.

The general pinout of the I/O cable is as follows:

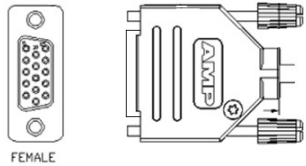
Pin No.	Signal	Color	Twisted & Shielded Wire	Plug
1	IN1	Orange	Twisted Pair 1	 <p>15-Pin High Density D-Type Female Connector</p>
2	IN2	Cyan		
3	OUT1	Blue	Twisted Pair 2	
4	OUT2	Red		
5	OUT3	Yellow	Twisted Pair 3	
13	OUT4	Green		
7	IN3	Purple	Twisted Pair 4	
8	IN4	Black		
9	VDDRET	White	Twisted Pair 5	
10	VDD	Brown		
11	IN5	Gray	Twisted Pair 6	
12	IN6	Pink		
14	VDDRET	White/Black	Twisted Pair 7	
15	VDD	White/Red		
6	INRET1-6	White/Yellow	Twisted Pair 8	
-	N.C.	White/Green		
*	PE	-	Drain Wire	

*** - Connector 15 Pin High Density Frame**



Pin Positions

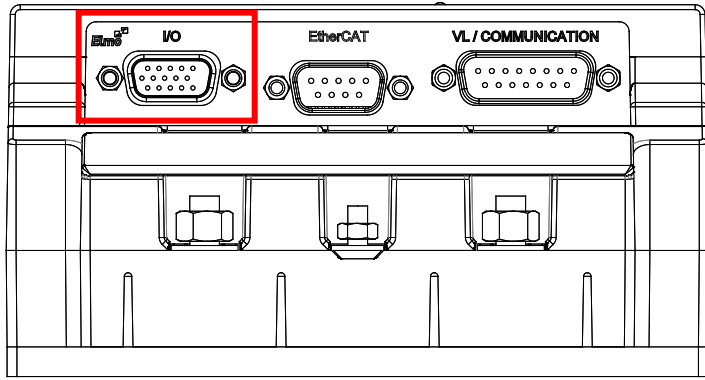

GEAGHV015A

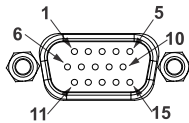

15-Pin High Density D-Type Male Connector

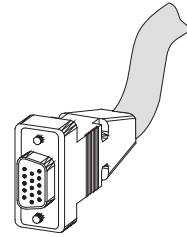

15-Pin High Density
D-Type Female Connector

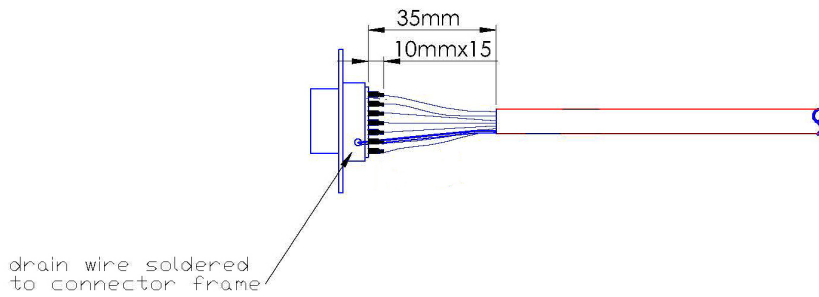

drain wire soldered
to connector frame

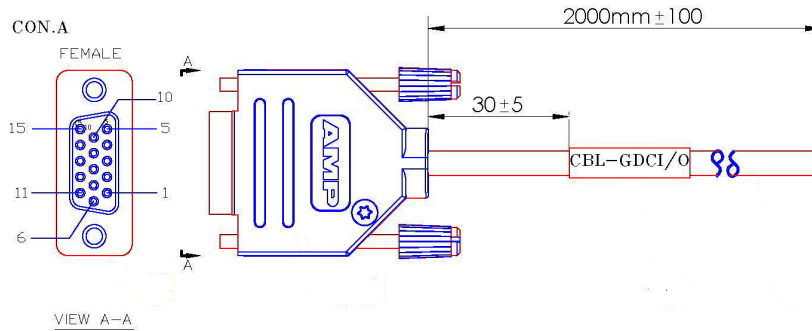

Figure 9: I/O Cable Drawing

Note: The specific functionality of each pin is described fully in the *Gold Eagle HV Installation Guide*.



Figure 4: I/O Cable Actual



3.5 EtherCAT or CAN Communication Cable

The EtherCAT/CAN communication cable is a 4-pair 28 AWG double-shielded twisted-pair cable. It is connected using a 9-pin D-type female connector to the Gold Eagle HV at the EtherCAT or CAN connector.

The cable is open on the user side so that it can be connected to the user communication connector.

The general pinouts of the EtherCAT communication cable is as follows:

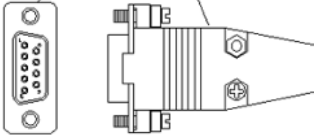
Pin No.	Signal	Color	Twisted & Shielded Wire	Plug
1	EtherCAT_IN_TX+/ Ethernet_TX+	Black	Twisted Pair 1	 <p>9-Pin D Type Female Connector</p>
6	EtherCAT_IN_TX-/ Ethernet_TX-	Red		
2	EtherCAT_IN_RX+/ Ethernet_RX+	Black	Twisted Pair 2	
7	EtherCAT_IN_RX-/ Ethernet_RX-	White		
3	EtherCAT_OUT_TX+	Black	Twisted Pair 3	
8	EtherCAT_OUT_TX-	Green		
4	EtherCAT_OUT_RX+	Black	Twisted Pair 4	
9	EtherCAT_OUT_RX-	Blue		
5	Shield	-	Drain Wire	

Pin Positions

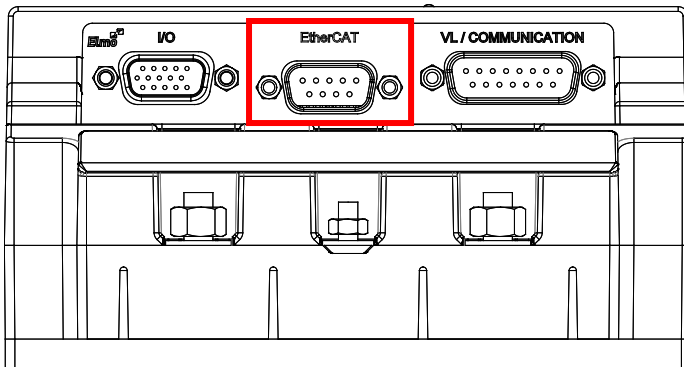

GEAGHV013A

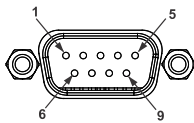

9-Pin D-Type Male Connector

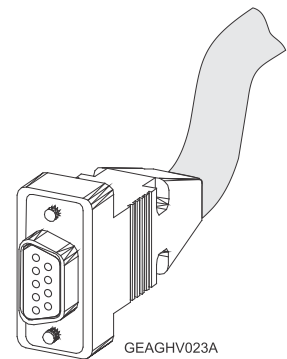

GEAGHV023A

9-Pin D-Type Female Connector

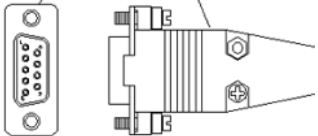

The general pinouts of the CAN communication cable is as follows:

Pin No.	Signal	Color	Twisted & Shielded Wire	Plug
1	CAN_IN_H	Black	Twisted Pair 1	 9-Pin D Type Female Connector
6	CAN_IN_L	Red		
2	N/C	Black	Twisted Pair 2	
7	CAN_GND	White		
3	CAN_OUT_H	Black	Twisted Pair 3	
8	CAN_OUT_L	Green		
4	N/C	Black	Twisted Pair 4	
9	CAN_GND	Blue		
5	Shield	-	Drain Wire	

Pin Positions

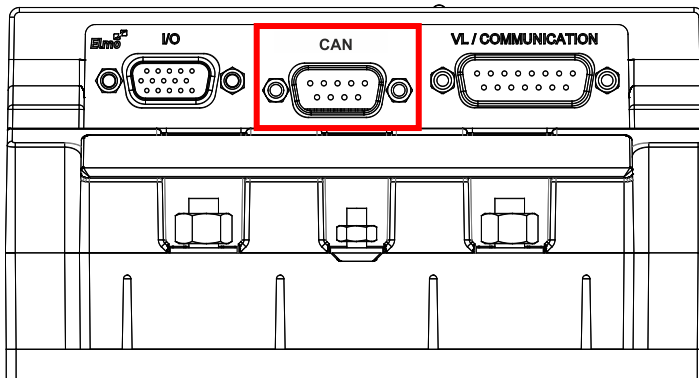

G_EAGHVCC05

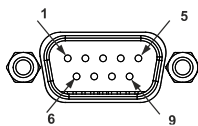

9-Pin D-Type Male Connector

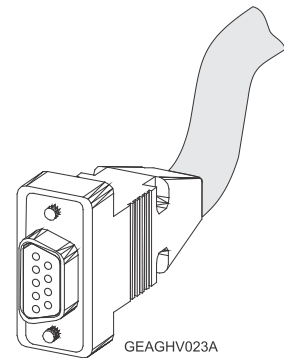

GEAGHV023A

9-Pin D-Type Female Connector



Notes: The specific functionality of each pin is described fully in the *Gold Eagle HV Installation Guide*.

The CAN terminator is used only for CAN applications. It is used to terminate the CAN communication line.

The CAN terminations prevent the CAN signal reflection at the end of the physical lines.

The reflection suppresses the CAN signal which may lead to Error Frames and causes the CAN controller message to be discarded. **120 Ohm resistors** are required on both physical ends of the CAN network to prevent the signal reflection.

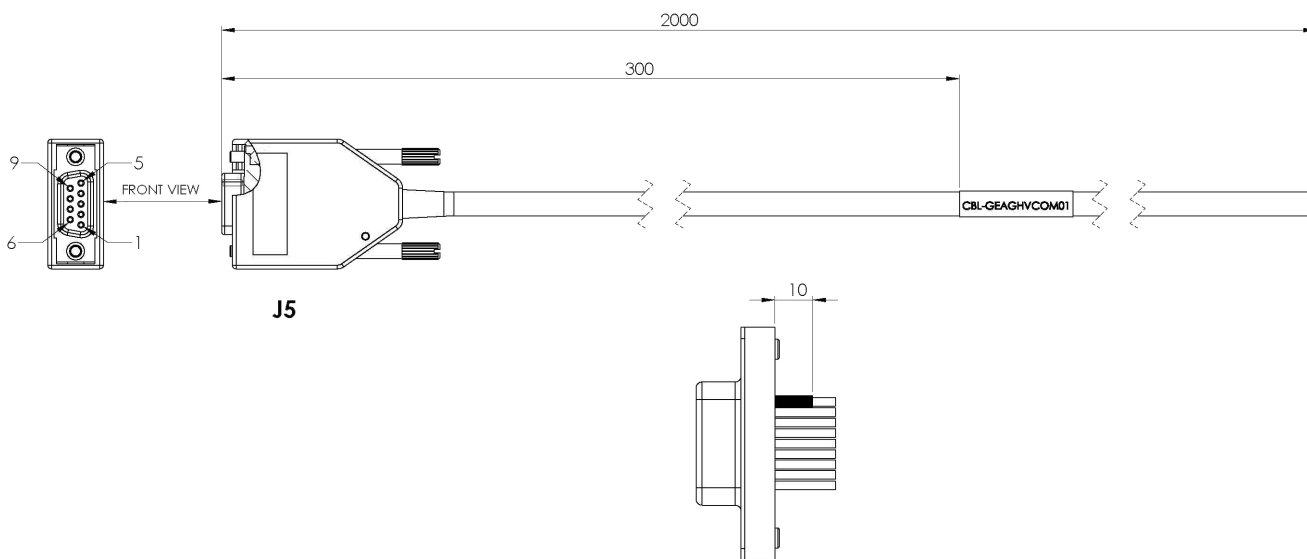

Figure 10: EtherCAT/CAN Communication Cable Drawing



Figure 11: EtherCAT/CAN Communication Cable Actual



3.6 VL/Communication Cable

The VL communication cable consists of two different cables. One cable is a 7-pair 28 AWG double-shielded twisted-pair cable. The other cable is a single-pair 24-AWG double shielded twisted-pair cable. It is connected using a 15-pin D-type female connector to the Gold Eagle HV VL/communication connector.

The cable is open on the user side so that it can be connected to the user interface connector.

The general pinouts of the VL communication cable is as follows:

Note: The USB connection can be either from the top mini USB connector or from the VL/Communication D-Type connector. Only one connector can be connected each time. The USB connectors cannot be connected simultaneously.

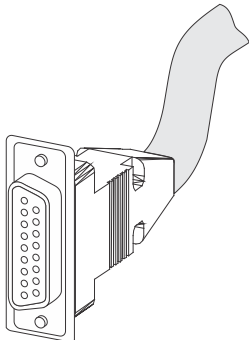
Pin No.	Signal	Color	Twisted & Shielded Wire	Plug	
1	USB D-	Black	Twisted Pair 1	 GEAGHV022A 15-pin D-Type Female Connector	
9	USB D+	Red			
2	USB_VBUS	Black	Twisted Pair 2		
10	USB COMRET	White			
4	RS-232_RX/RS-422_RX+	Black	Twisted Pair 3		
12	RS-232_TX/RS-422_RX-	Green			
5	RS-422_TX-	Black	Twisted Pair 4		
13	RS-422_TX+	Blue			
11	RS COMRET	Black	Twisted Pair 5		
-	N. C. Not in use	Yellow			
15	N. C. Not in use		-		
7	N.C. Not in use		-		
3	Shield	-	Drain Wire		
S, T, or H option type(optional backup supply) Cable 2					
14	VL+, +24 V Auxiliary Supply Input Positive	Cable 2 Red	Twisted Pair 1		
6	VL-, 24 V Auxiliary Supply Input Return	Cable 2 Black			
8	Shield	-	Drain Wire		



Pin Positions

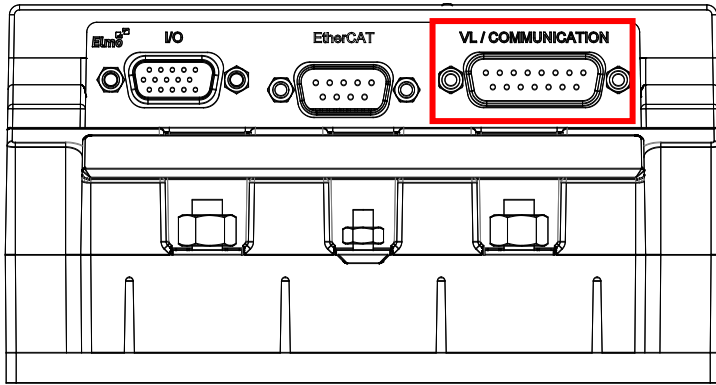

GEAGHV012A

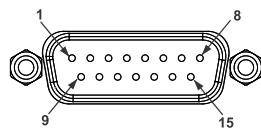

15-Pin D-Type Male Connector

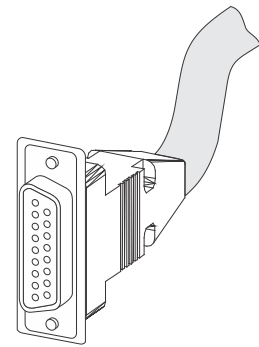

GEAGHV022A

15-pin D-Type Female Connector

Note: The specific functionality of each pin is described fully in the *Gold Eagle HV Installation Guide*.

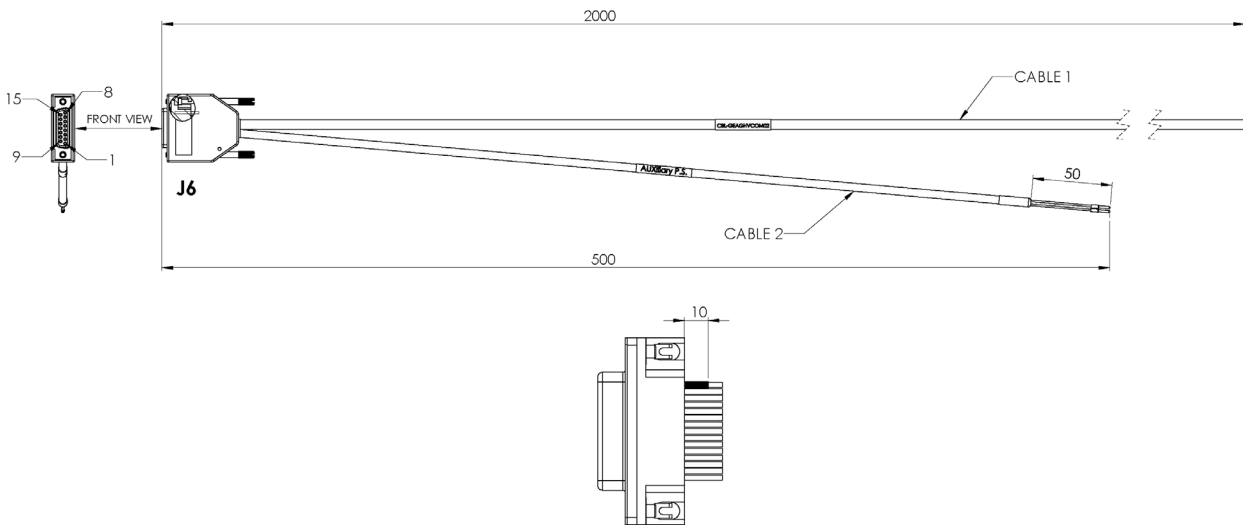

Figure 12: VL/Communication Cables Drawing



Figure 13: VL/Communication Cables Actual



Inspiring Motion

Since 1988

For a list of Elmo's branches, and your local area office, refer to the Elmo site www.elmomc.com

